

8.8		8.8	
8.8		8.8	
8.8		8.8	
8.8		8.8	

项目		规格
通信协议		IEC 61158 Type 12, IEC 61800-7 CiA 402 Drive Profile
	SDO	SDO 请求、SDO 应答
	PDO	可变 PDO 映射
	CiA402	轮廓位置模式 (pp) 轮廓速度模式 (pv) 轮廓转矩模式 (pt) 原点回归模式 (hm) 同步周期位置模式 (csp) 同步周期速度模式 (csv) 同步周期转矩模式 (cst)
传输协议		100BASE-TX (IEEE802.3)
物理层	最大距离	100M
	接口	RJ45 * 2 (INT, OUT)

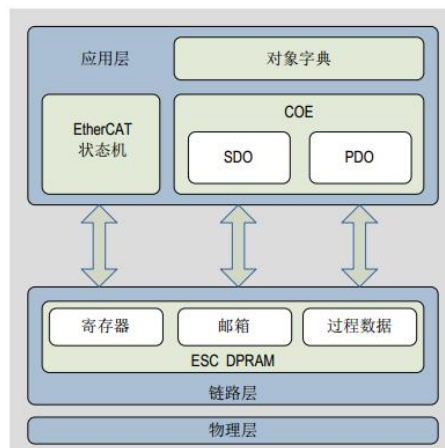

□





□



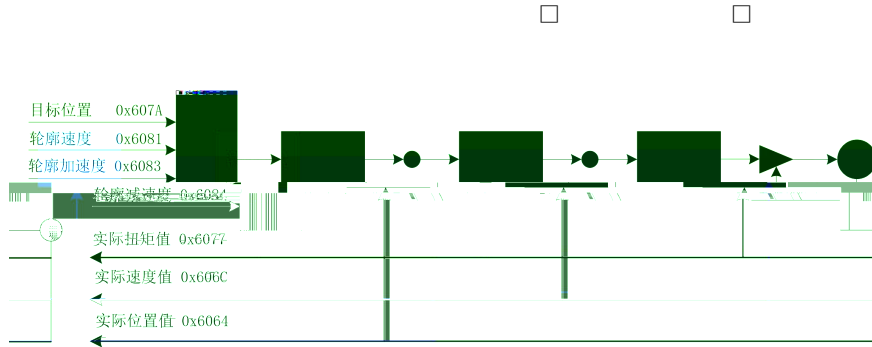















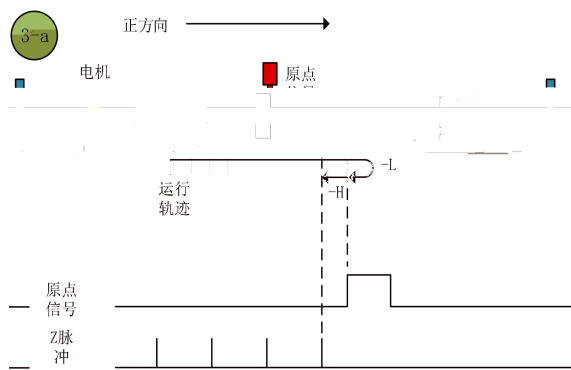
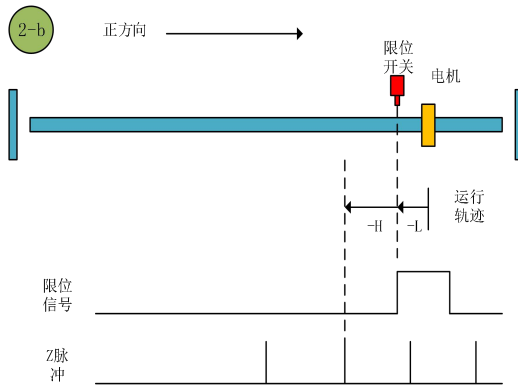
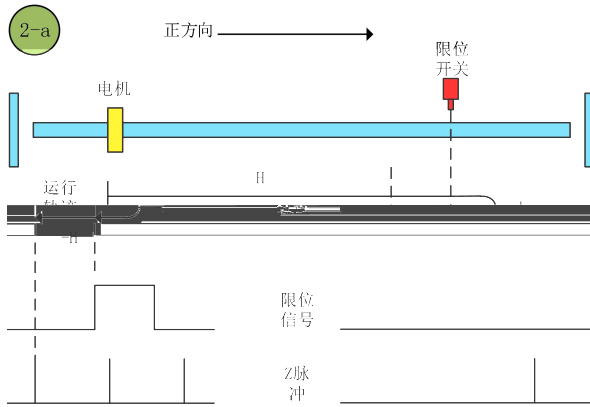

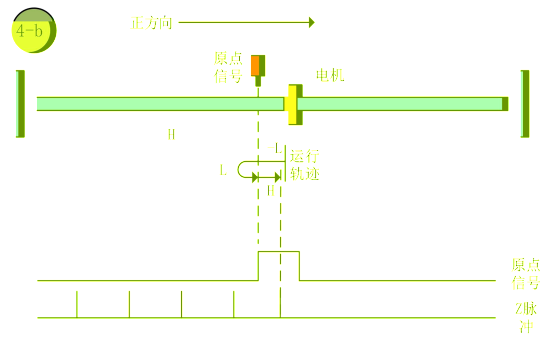
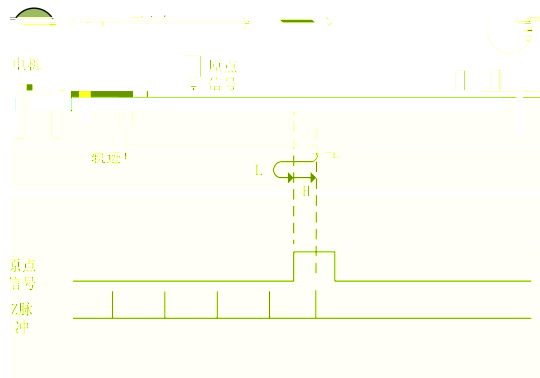
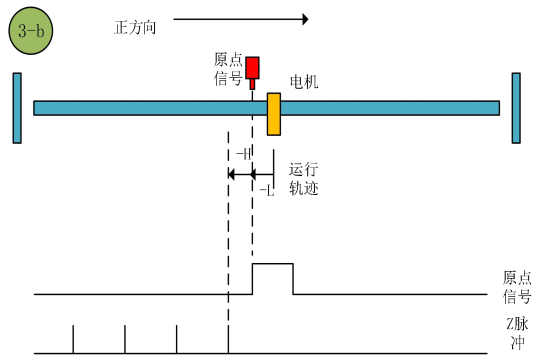

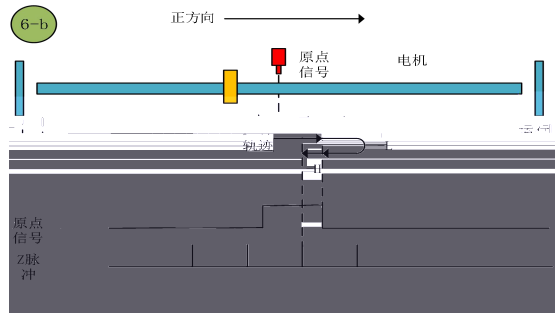
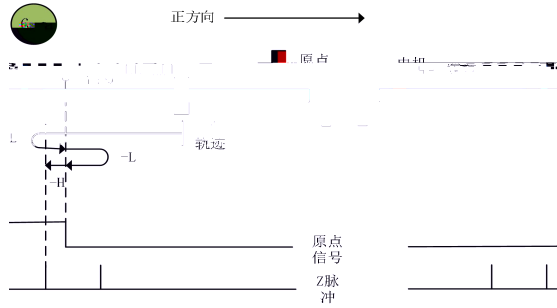
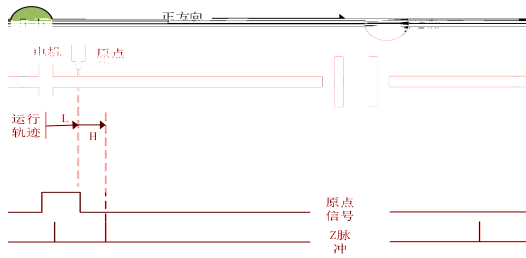
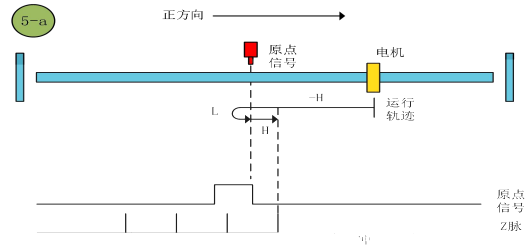

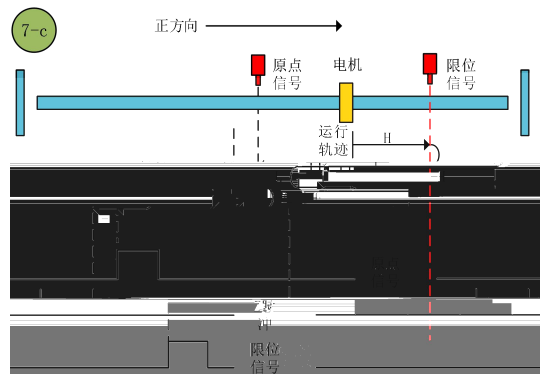
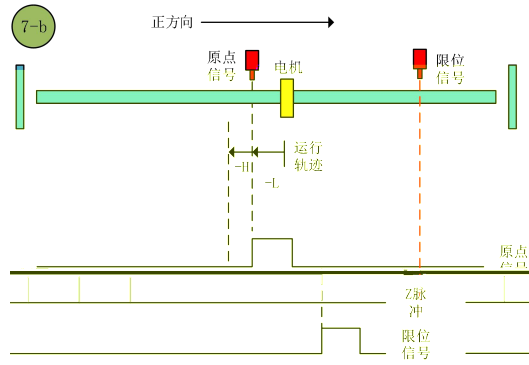
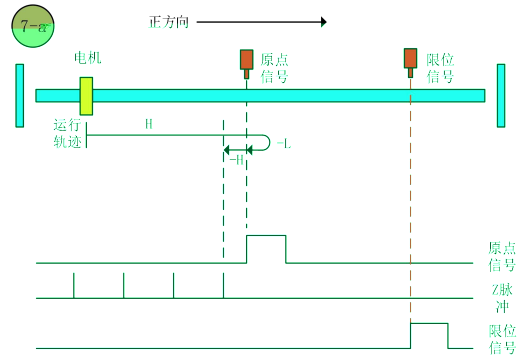

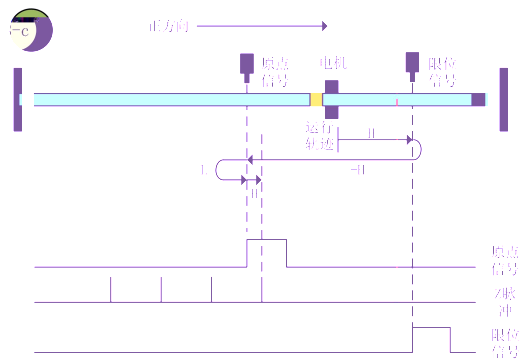
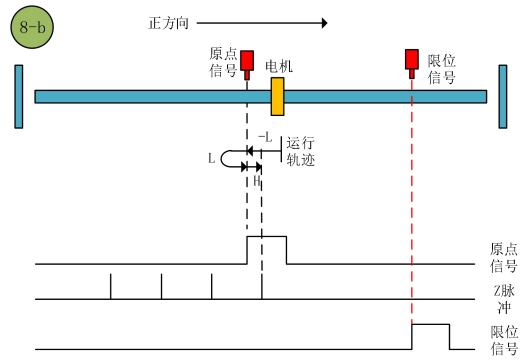
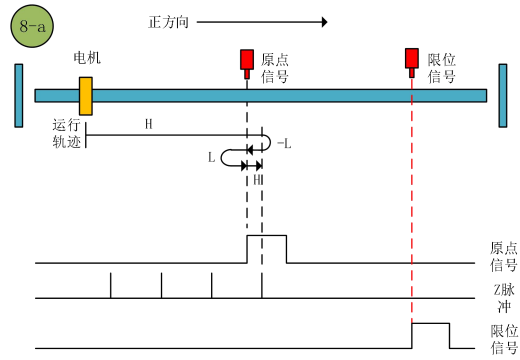







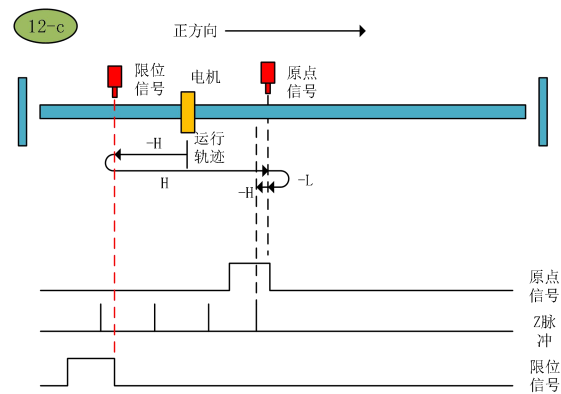
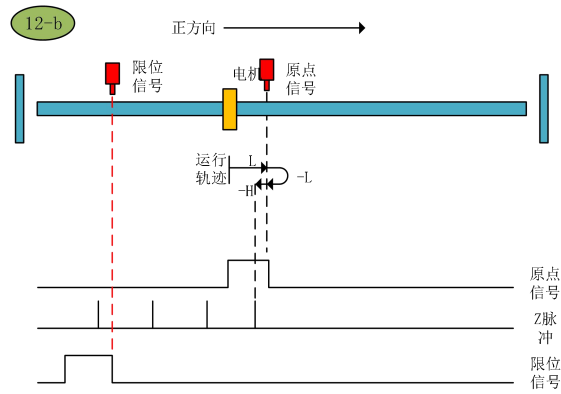
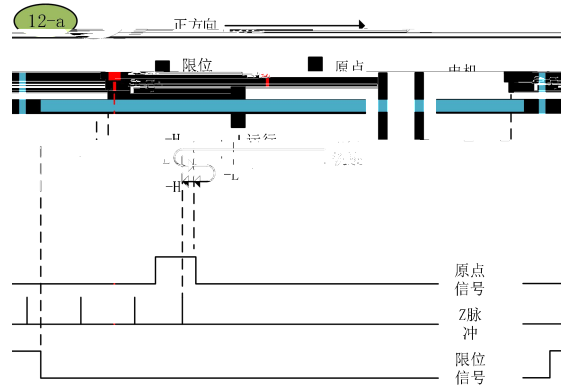



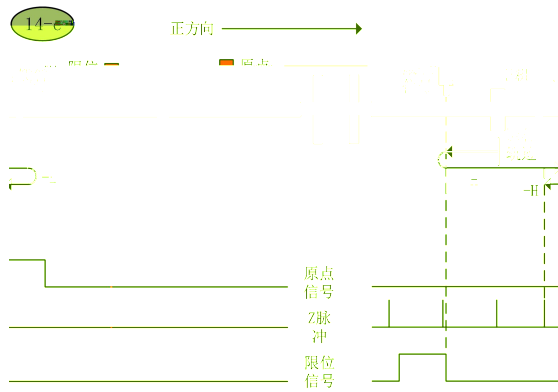
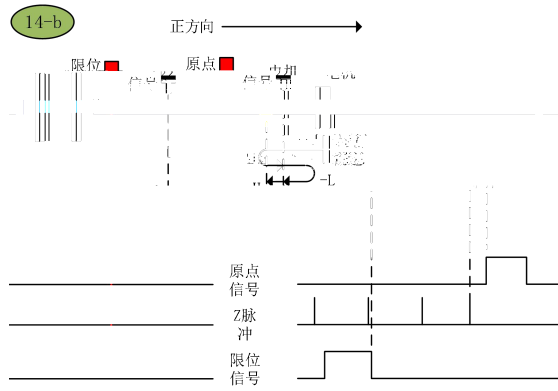
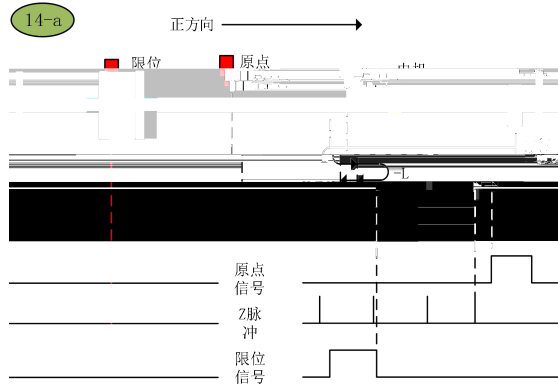

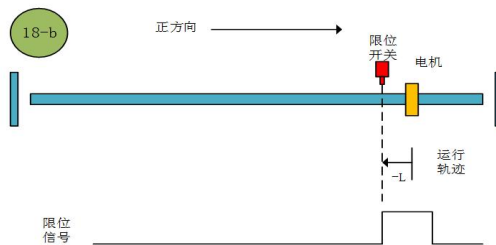
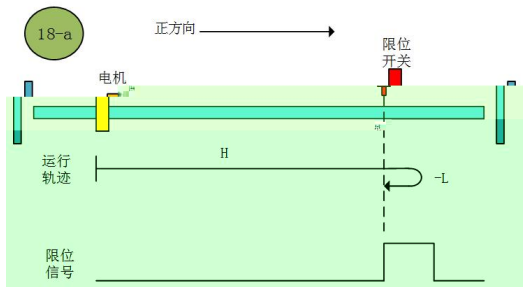
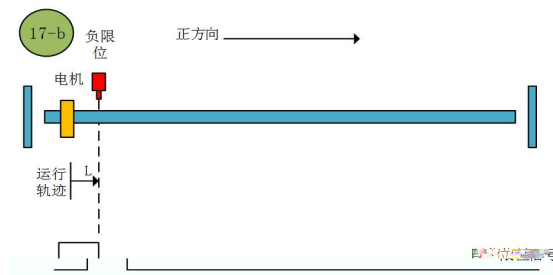
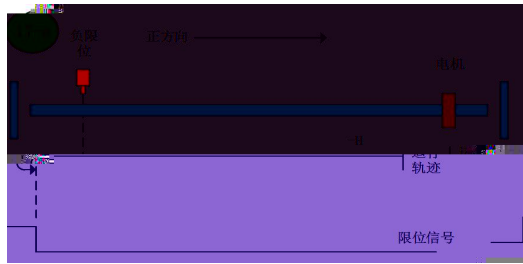



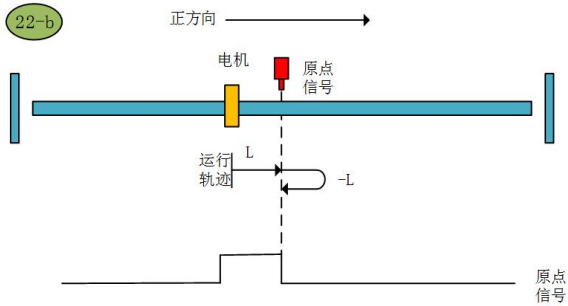
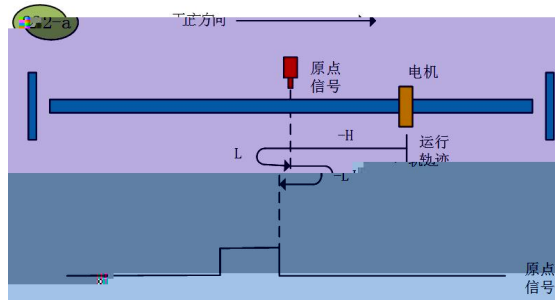
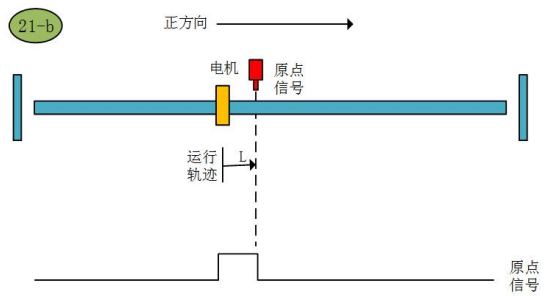
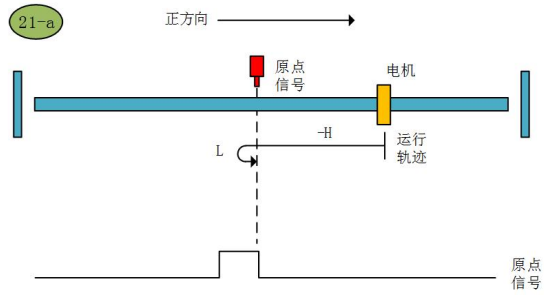

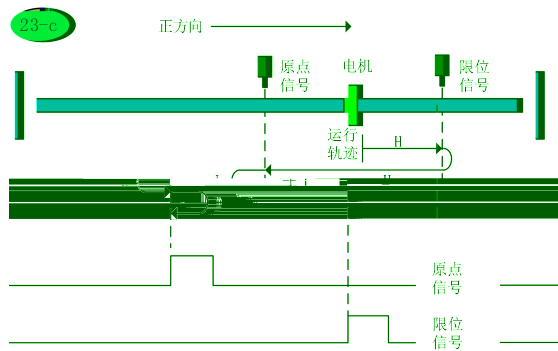
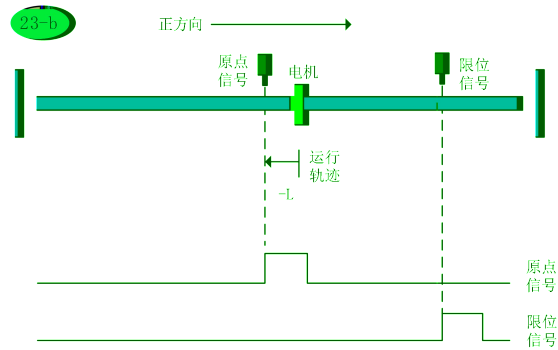
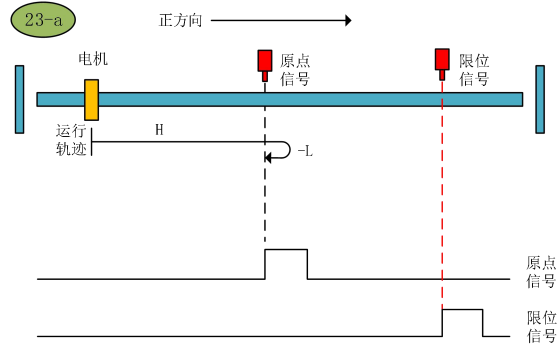





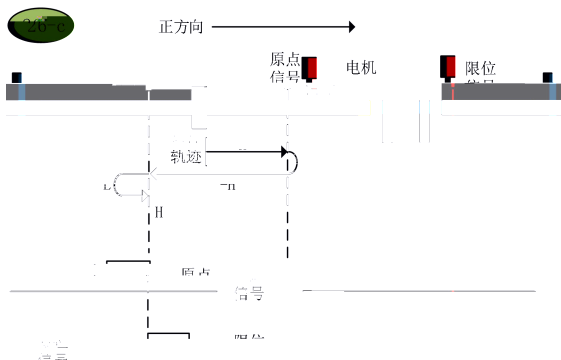
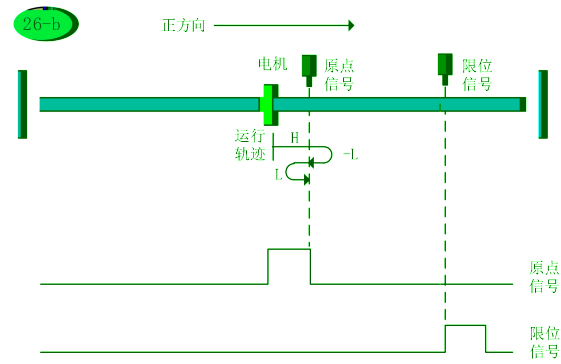
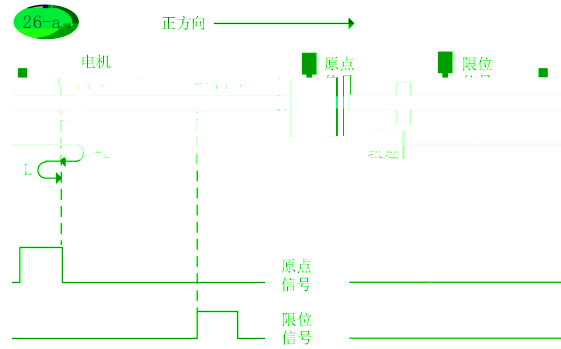

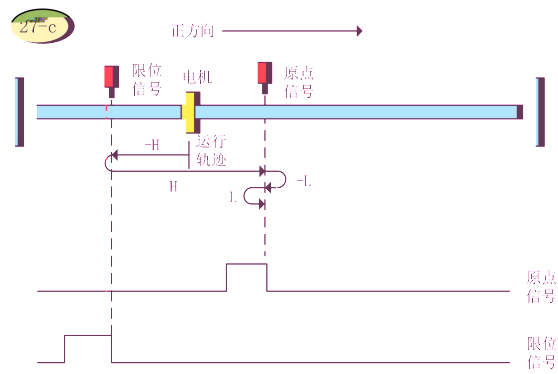
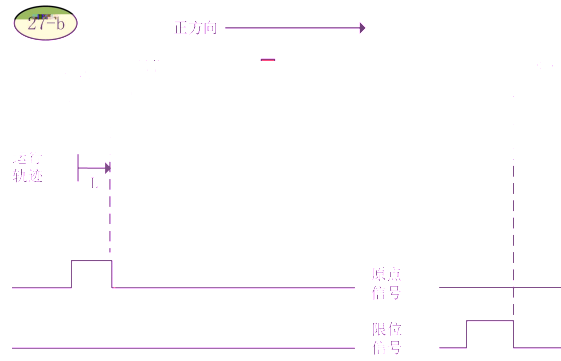
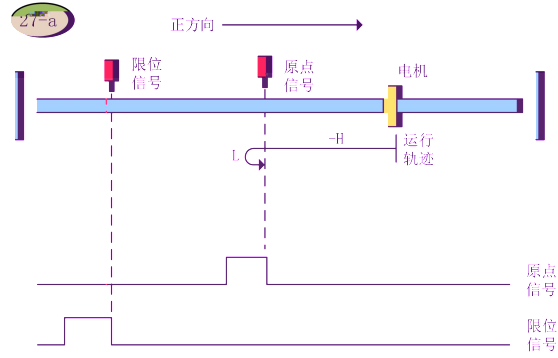

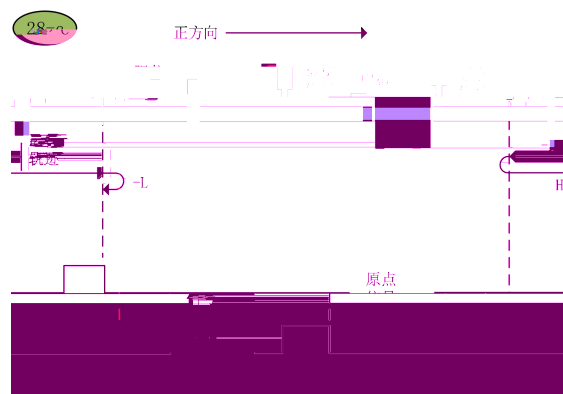
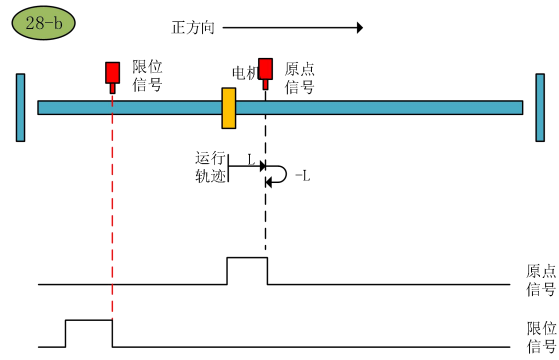
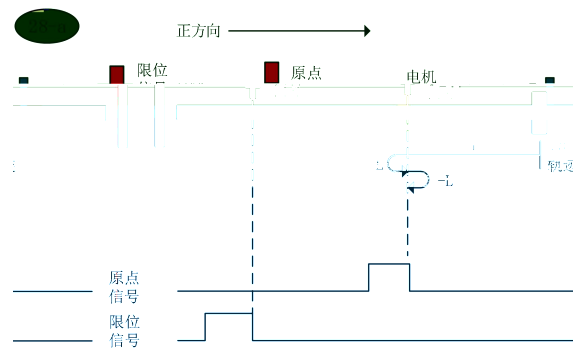





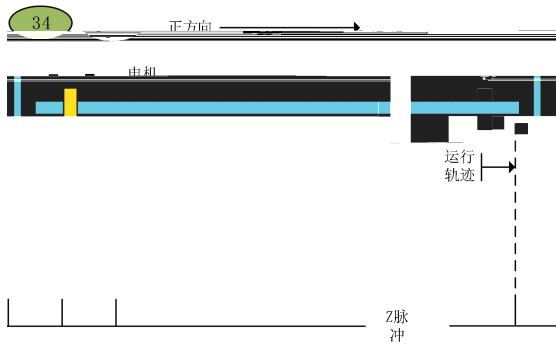
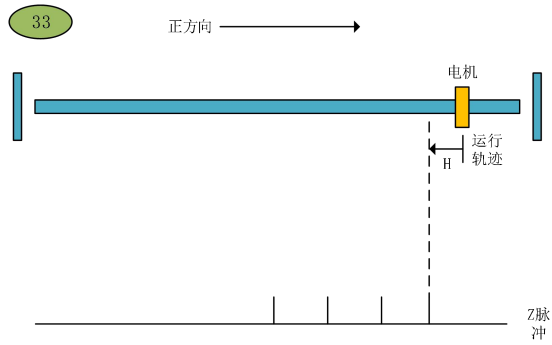





















...

...







<table border="1" style="margin: auto;"> <tr> <td></td> <td></td> <td></td> </tr> <tr> <td></td> <td></td> <td></td> </tr> </table>											

<table border="1" style="margin: auto;"> <tr> <td></td> <td></td> <td></td> </tr> <tr> <td></td> <td></td> <td></td> </tr> </table>											























			1/0 5 6E	d1K	





---









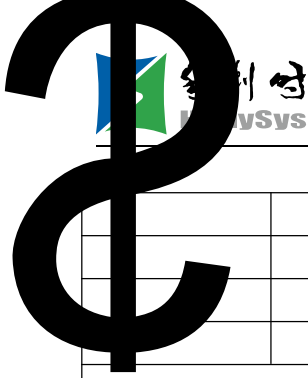

13>001-099W@b K01EU@ 20-1E@ 0 (x•b











































□ □					











□					

□					



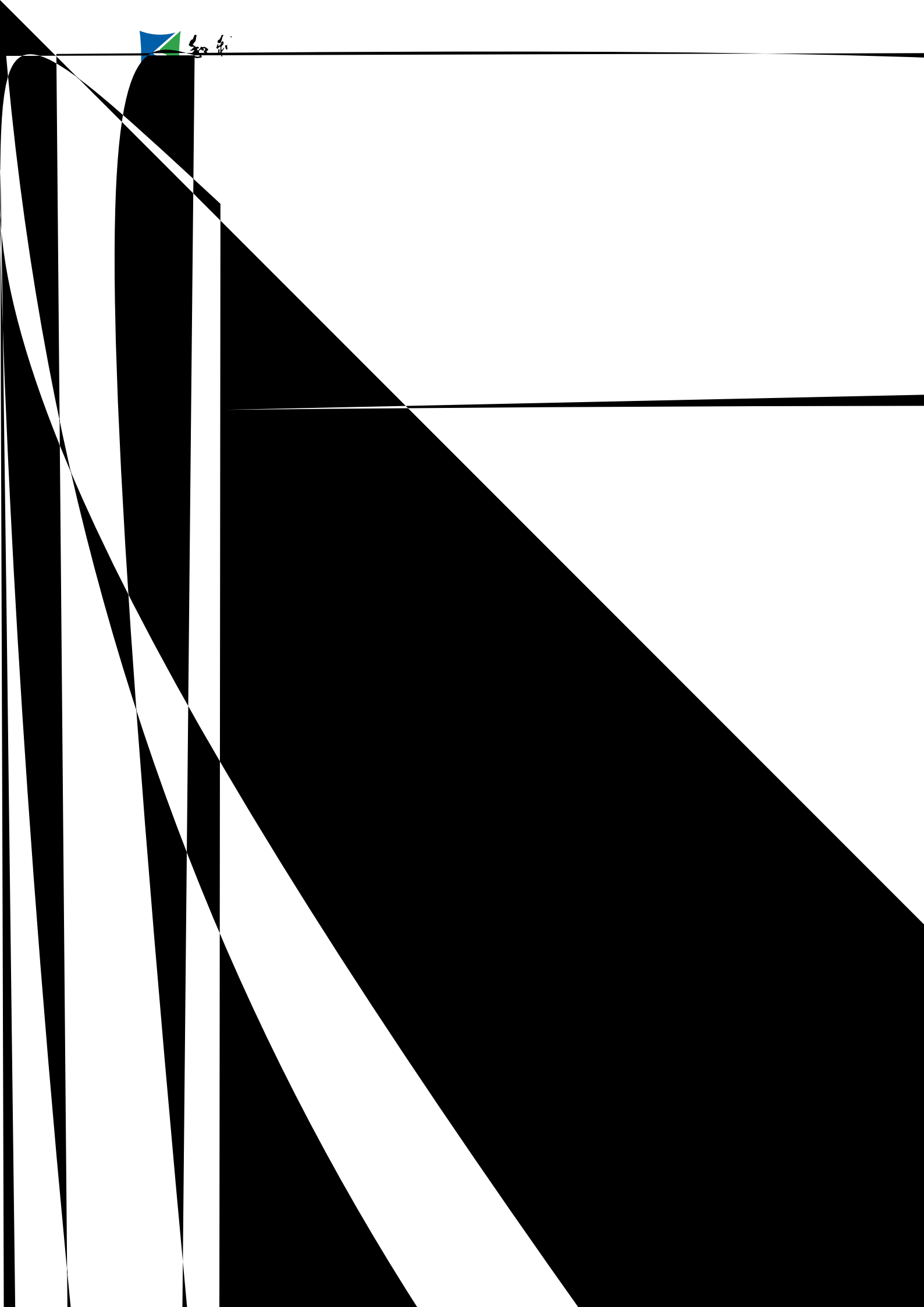





□					



<input type="checkbox"/> <input type="checkbox"/>					



$1000 \times 20\% = 200$					







EQMB

	4
↓	



	<input type="checkbox"/> <input type="checkbox"/> <input type="checkbox"/> <input type="checkbox"/> <input type="checkbox"/> <input type="checkbox"/>				
					<input type="checkbox"/> <input type="checkbox"/> <input type="checkbox"/> <input type="checkbox"/> <input type="checkbox"/> <input type="checkbox"/>







<table border="1" style="margin: auto;"> <thead> <tr style="background-color: #cccccc;"> <th></th> <th></th> <th></th> </tr> </thead> <tbody> <tr><td></td><td></td><td></td></tr> <tr><td></td><td></td><td></td></tr> <tr><td></td><td></td><td></td></tr> <tr><td></td><td></td><td></td></tr> <tr><td></td><td></td><td></td></tr> <tr><td></td><td></td><td></td></tr> <tr><td></td><td></td><td></td></tr> <tr><td></td><td></td><td></td></tr> <tr><td></td><td></td><td></td></tr> <tr><td></td><td></td><td></td></tr> </tbody> </table>																																						
<table border="1" style="margin: auto;"> <tbody> <tr> <td></td> <td colspan="4"></td> </tr> <tr> <td></td> <td></td> <td></td> <td></td> <td></td> </tr> <tr> <td></td> <td></td> <td></td> <td></td> <td></td> </tr> <tr> <td></td> <td></td> <td></td> <td></td> <td></td> </tr> <tr> <td></td> <td></td> <td></td> <td></td> <td></td> </tr> </tbody> </table>																																						

















<table border="1" style="margin: auto;"> <tr> <td></td> <td></td> <td></td> <td></td> <td></td> </tr> <tr> <td></td> <td></td> <td></td> <td></td> <td></td> </tr> </table>															





<div style="display: flex; justify-content: space-around; align-items: center;"> <div style="text-align: center;">□</div> <div style="text-align: center;">□</div> </div> <hr style="width: 20%; margin: 10px auto;"/>					









□







<table border="1" style="margin: auto;"> <tr> <td></td> <td></td> <td></td> <td></td> <td></td> <td></td> <td></td> <td></td> </tr> <tr> <td></td> <td></td> <td></td> <td></td> <td></td> <td></td> <td></td> <td></td> </tr> </table>																							



<table border="1" style="margin: auto;"> <tr style="background-color: #cccccc;"> <td></td> <td></td> </tr> <tr> <td></td> <td></td> </tr> <tr> <td></td> <td></td> </tr> <tr> <td></td> <td></td> </tr> </table>													



















Add Route Dialog

Enter Host Name / IP:  Refresh Status Broadcast Search

Host Name	Connected	Address	AMS NetId	TwinCAT	OS Version	Comment

Route Name (Target):

AmsNetId:

Transport Type:

Address Info:

Host Name  IP Address

Connection Timeout (s):

Route Name (Remote):

Target Route:  Project  Static  Temporary

Remote Route:  None  Static  Temporary

Add Route Close

Add Route Dialog

Enter Host Name / IP:  Refresh Status Broadcast Search

Host Name	Connected	Address	AMS NetId	TwinCAT	OS Version	Comment
20573	X	169.254.24...	5.34.213.115.1.1	2.11.2252	Win CE (7.0)	
NB00098		169.254.18...	169.254.18.123	2.11.2252	Win...	

Logon Information

Enter a user name and password that is valid for the remote system.

User name:

Password:

OK Cancel

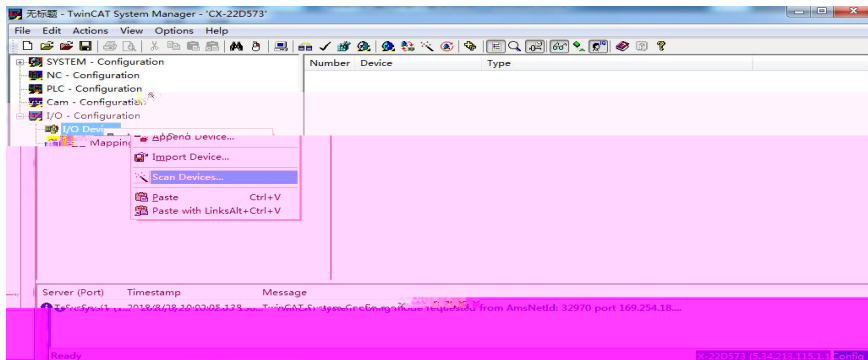
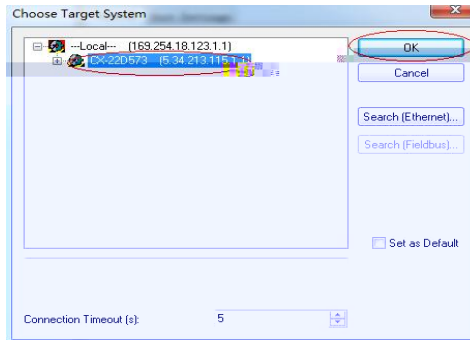
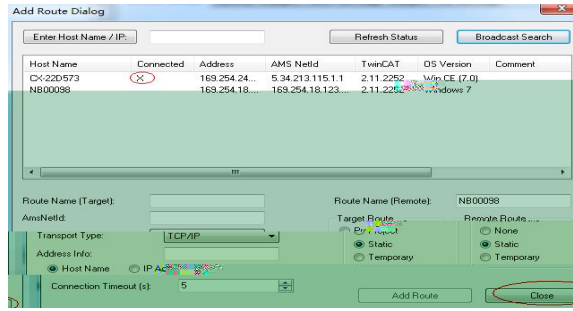

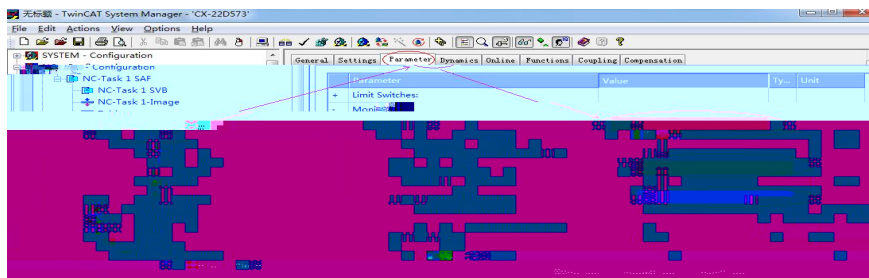
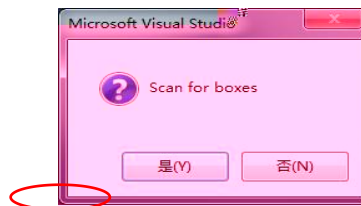
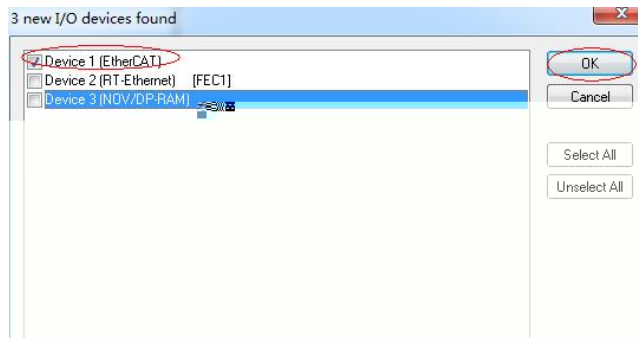







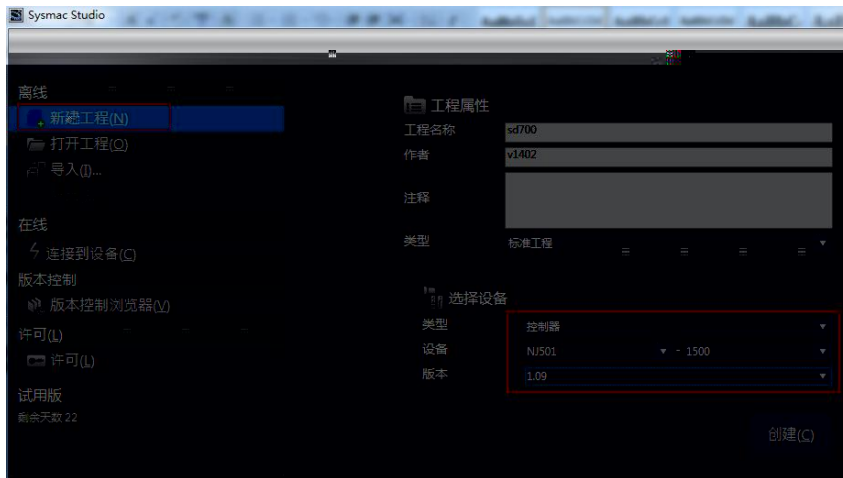
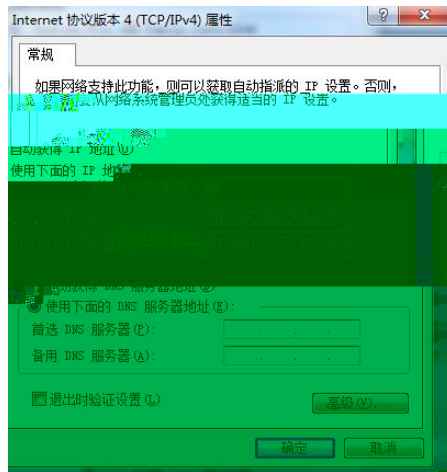

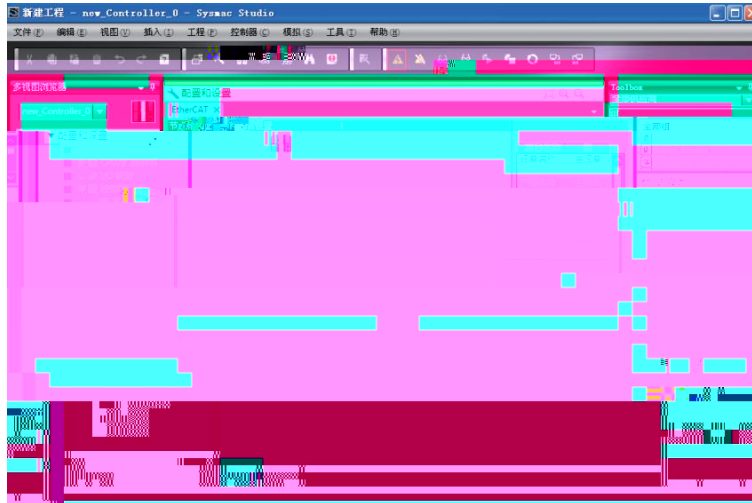

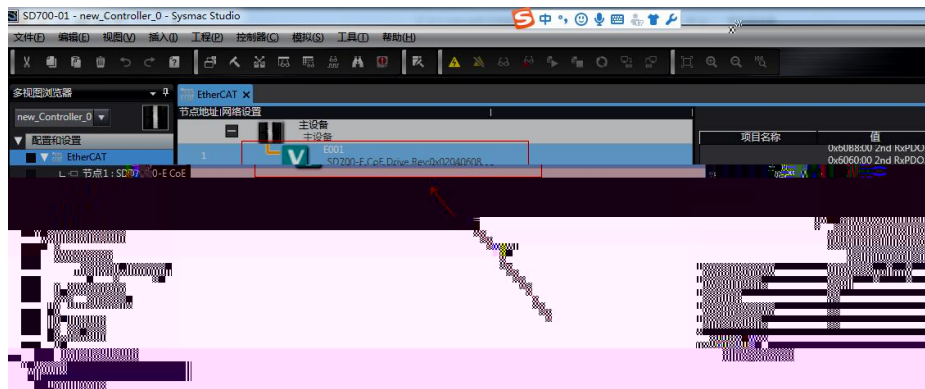
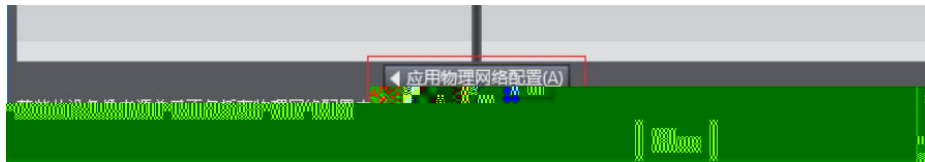
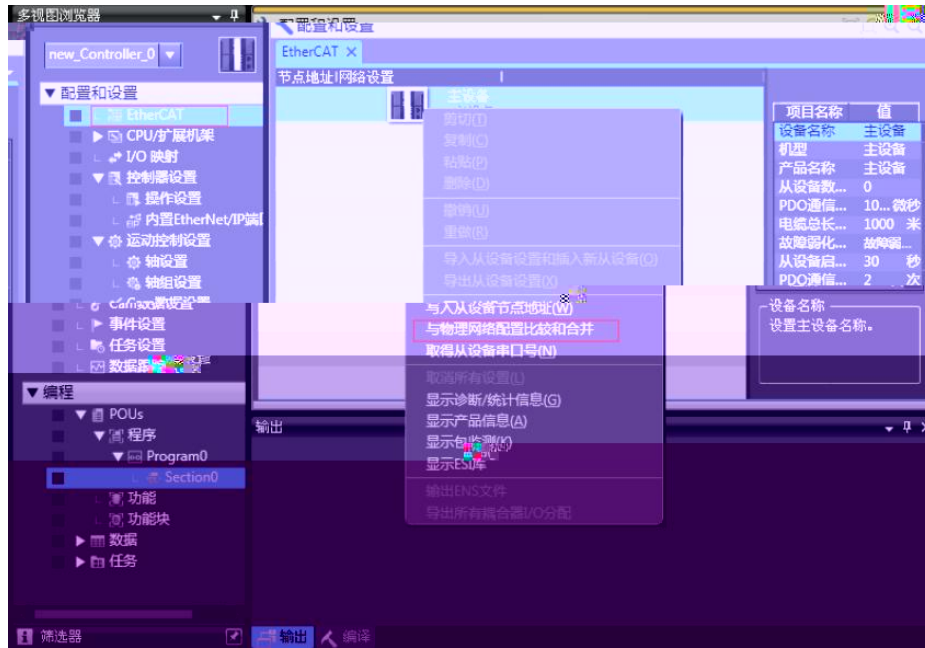

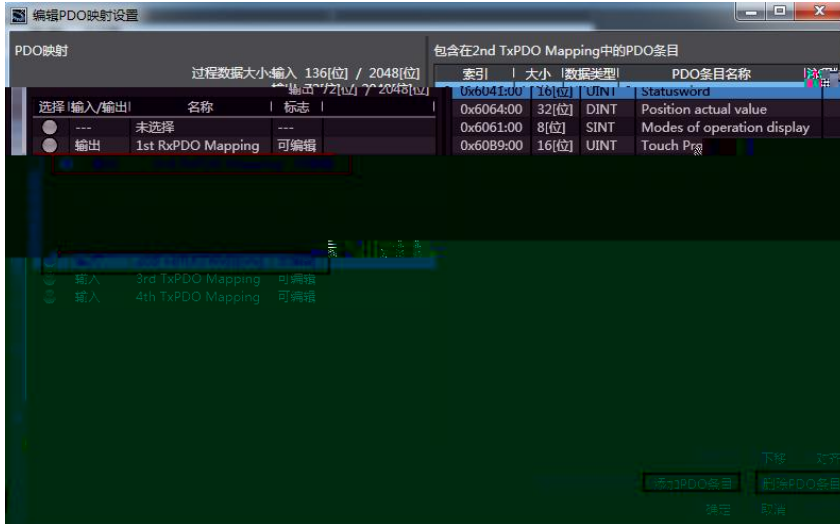
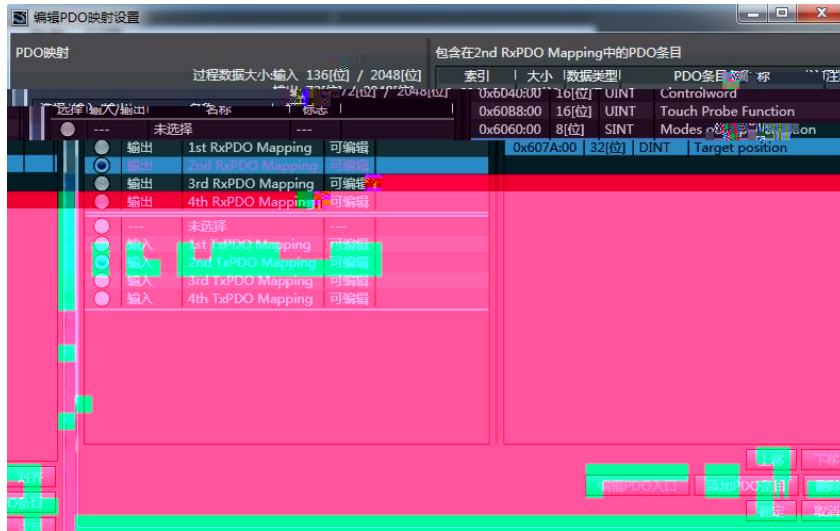
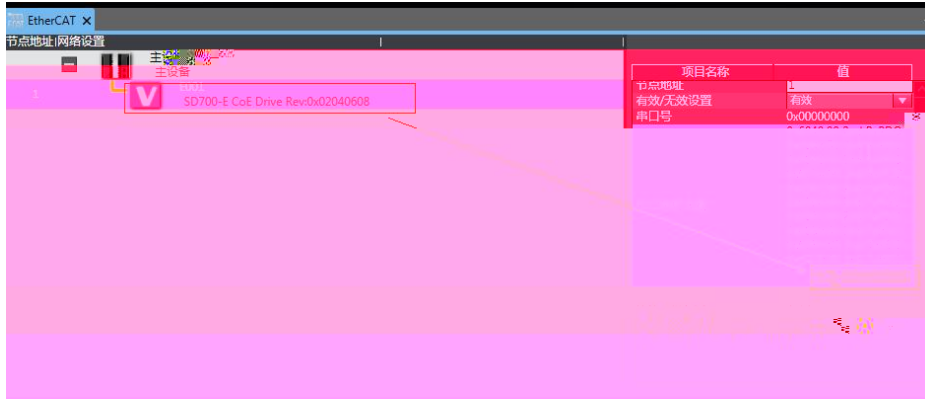

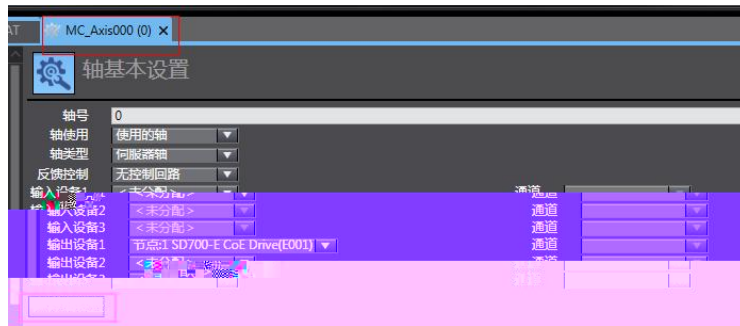
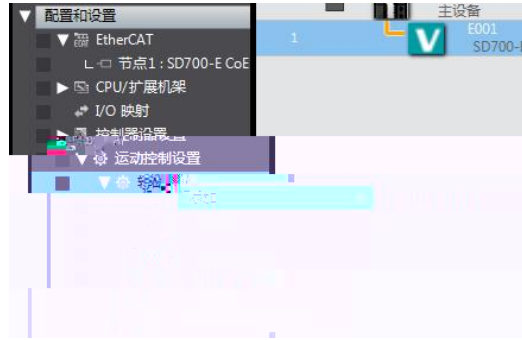

详细设置

恢复默认值

功能名称	设备	过程数据
输出(控制器到设备)		
1. Controlword	节点1 SD700-E CoE Drive(E001)	6040h-00.0(2nd RxPDC)
3. Target position	节点1 SD700-E CoE Drive(E001)	607Ah-00.0(2nd RxPDC)
5. Target velocity	<未分配>	<未分配>
7. Target torque	节点1 SD700-E CoE Drive(E001)	<未分配>
9. Max profile Velocity	<未分配>	<未分配>
11. Modes of operation	节点1 SD700-E CoE Drive(E001)	6060h-00.0(2nd RxPDC)
15. Positive torque limit value	<未分配>	<未分配>
16. Negative torque limit value	<未分配>	<未分配>
21. Touch probe function	节点1 SD700-E CoE Drive(E001)	60B8h-00.0(2nd RxPDC)
44. Software Switch of Encoder's Input	<未分配>	<未分配>
输入(设备到控制器)		
数字输入		

输入(设备到控制器)		
22. Statusword	节点1 SD700-E CoE Drive(E001)	6041h-00.0(2nd TxPDC)
23. Position actual value	节点1 SD700-E CoE Drive(E001)	6064h-00.0(2nd TxPDC)
24. Velocity actual value	<未分配>	<未分配>
25. Torque actual value	<未分配>	<未分配>
27. Mode of operation	<未分配>	<未分配>

数字输入		
28. Positive limit switch	节点1 SD700-E CoE Drive(E001)	60FDh-00.1(2nd TxPDC)
29. Negative limit switch	节点1 SD700-E CoE Drive(E001)	60FDh-00.0(2nd TxPDC)
30. Immediate Stop Input	<未分配>	<未分配>
32. Encoder Phase Z Detection	<未分配>	<未分配>
33. Home switch	节点1 SD700-E CoE Drive(E001)	60FDh-00.2(2nd TxPDC)
37. External Latch Input 1	<未分配>	<未分配>
38. External Latch Input 2	<未分配>	<未分配>

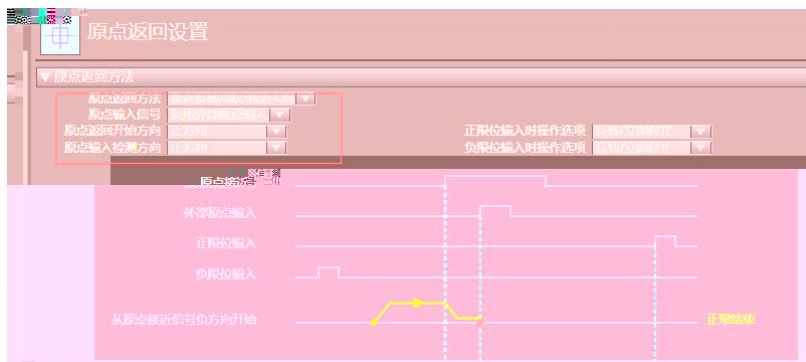
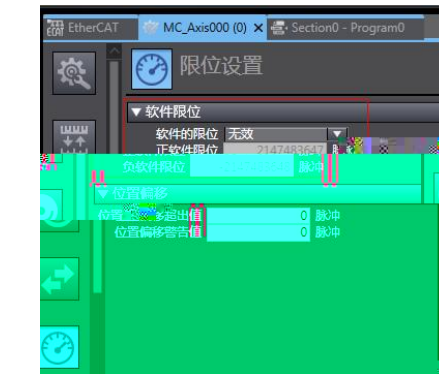
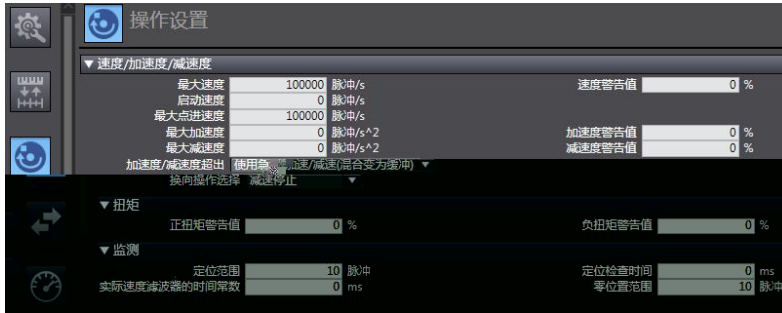
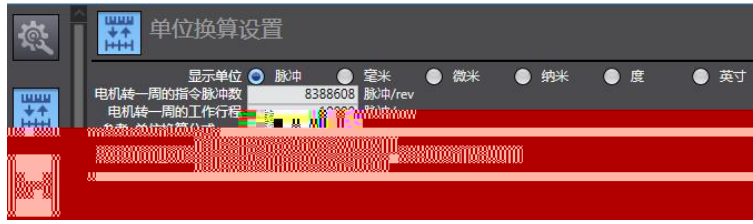

		<input type="checkbox"/>
		<input type="checkbox"/>
		<input type="checkbox"/>

